

Makita

PARTI DI RICAMBIO

Modello M445x 230V~

Cod. 99611BEB

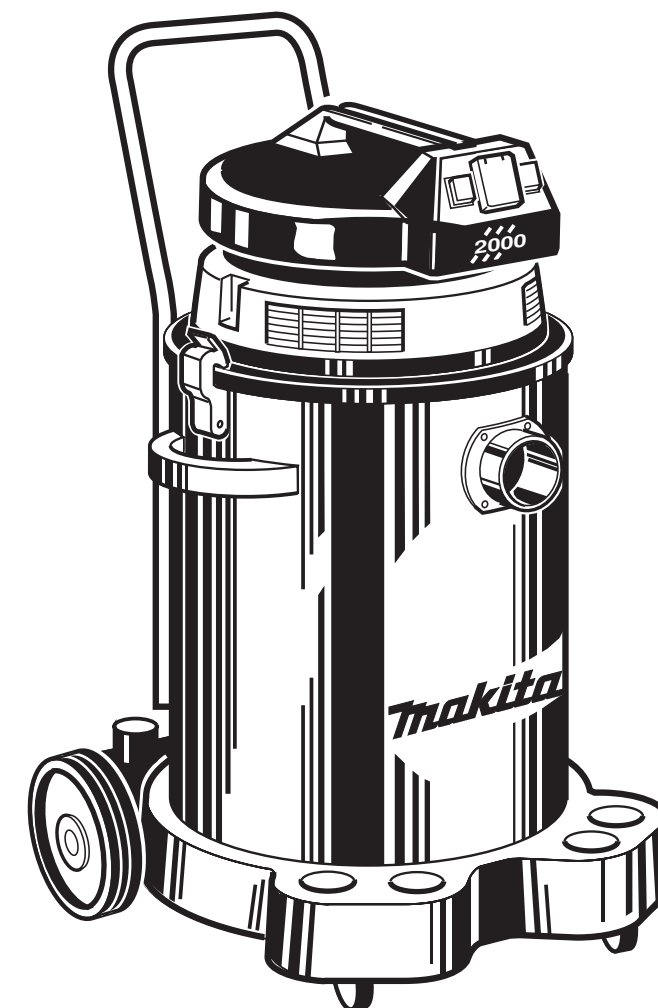



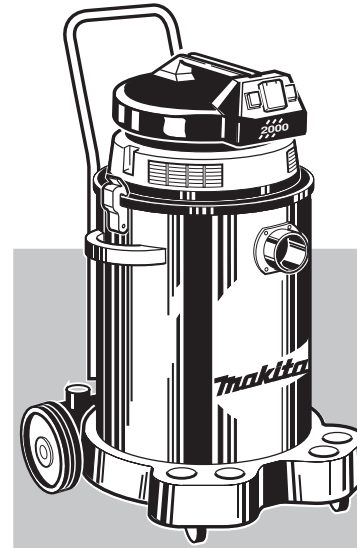
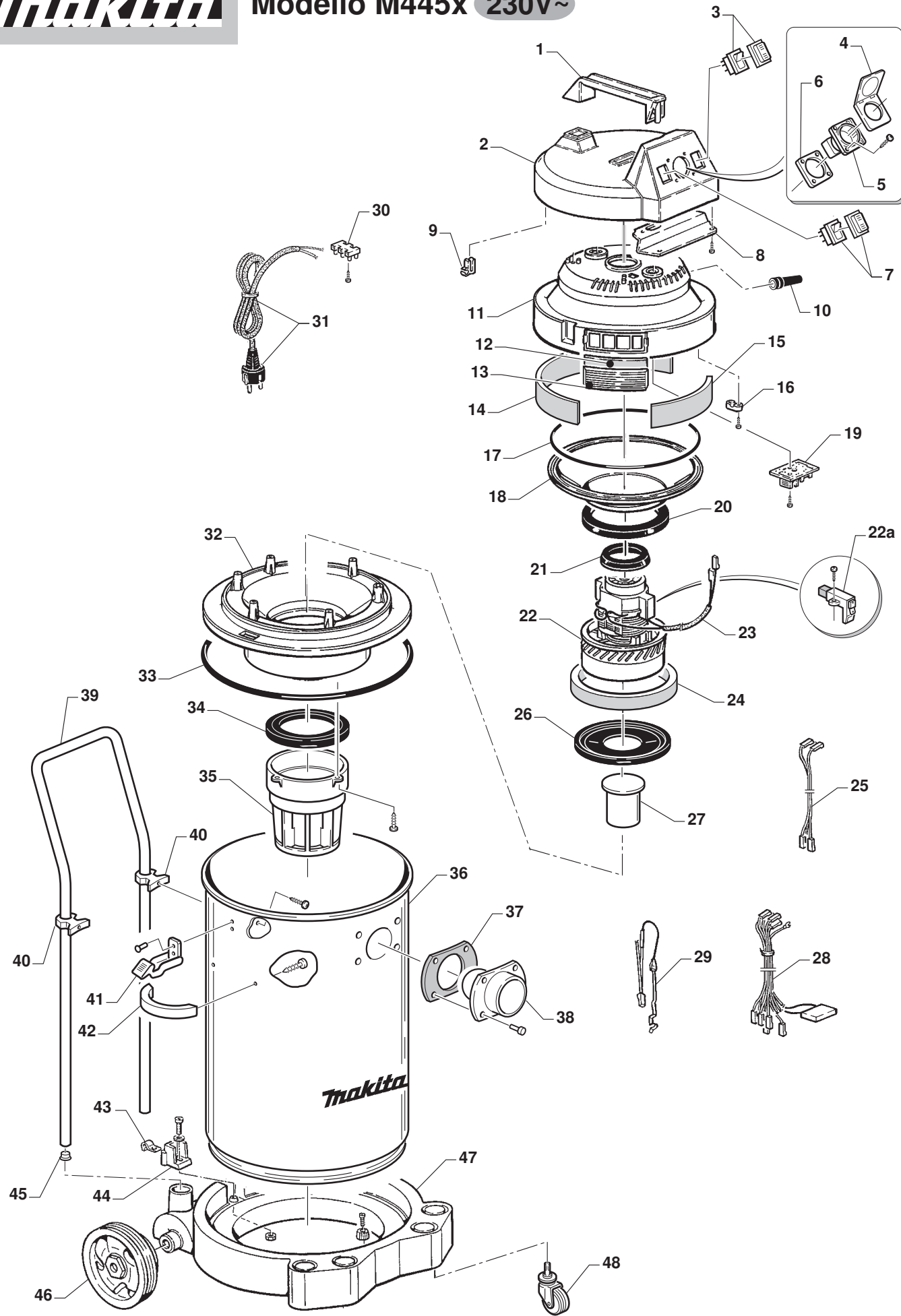

Makita

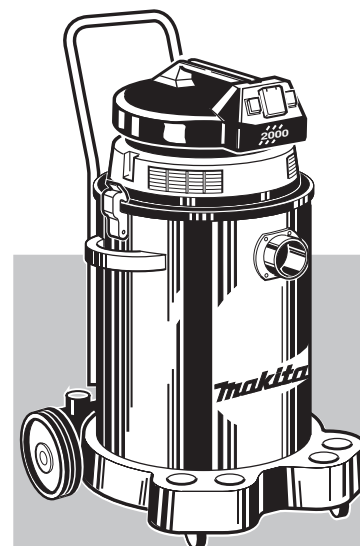
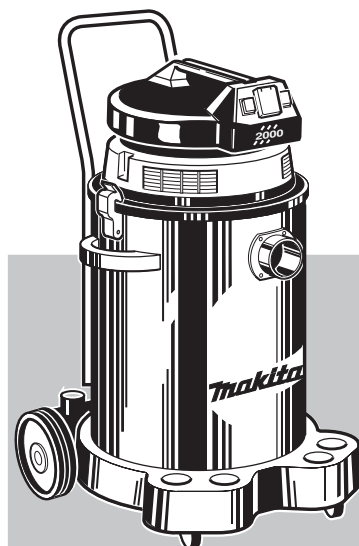

Blank lined area for notes or additional information.

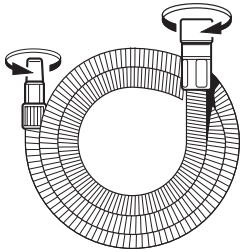
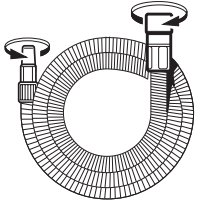
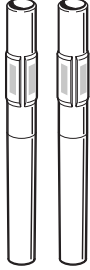

Pos.	Descrizione	Codice	Prezzo € (Cad)
01	Impugnatura	50310B8B
02	Calotta	50305B8B
03	Interruttore bipolare nero	80041BDN
04	Cornice + coperchio	80202B8N
05	Presa Schuko	80200B8N
06	Ghiera per presa	50315BDV
07	Interruttore unipolare	80042BDN
08	Piastra di chiusura	50300BDV
09	Forcella fermacavo	50335BEN
10	Guidacavo	50338BEN
11	Coprimotore	50181B0A
12	Filtro alla griglia	83021B8X
13	Griglia uscita aria	50170B8A
14	Silenziatore lungo alla calotta	83022B8X
15	Silenziatore corto alla calotta	83023B8X
16	Fermacavo	50333BEN
17	Guarnizione tonda	70016B8N
18	Diaframma	50104B9V
19	Scheda elettronica integrata	80209BDX
20	Guarnizione tenuta motore	70057B0N
21	Ammortizzatore superiore motore	70062B0N
22	Motore by-pass 1200W	20051B0X
22a	Inserto porta spazzole completo per motore ED	80050B0X
23	Tubetto PVC nero mm. 110 - ø 6 mm.	60235BHN
24	Anello silenziatore	83020B8X
25	Cavetti verde/giallo l= 360 mm	80099BEV
26	Ammortizzatore supporto motore	70046B5N
27	Galleggiante	50077B0V
28	Serie cavetti	80102BEV
29	Lamella correnti elettrostatiche	30076B5X
30	Morsetto tripolare	80029B0I
31	Cavo di alimentazione	80017B0N
32	Supporto motore	50064BEB
33	Tondino gommaspugna ø 5 mm.	70016B0N
34	Cuscinetto in gomma	70045B5N
35	Cestello portacartuccia	50102B5N
36	Contenitore	10002B0X
37	Guarnizione	70082B5X
38	Raccordo entrata aria	50079BEB
39	Impugnatura a forcella	40024B5X
40	Ritegno per asta cromata	01900BEB
41	Cerniera completa	01016BEB
42	Impugnatura contenitore	50116BEB
43	Molla per ritegno	30064B5X
44	Ritegno di fissaggio	50101BEB
45	Tappo per impugnatura a forcella	50375B5N
46	Ruota posteriore	60057B5N
47	Carrello	50124BEB
48	Ruota anteriore	30083B5X

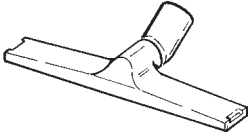
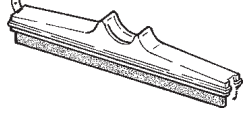
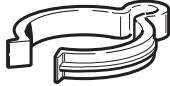
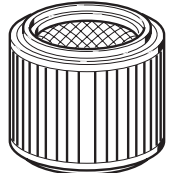
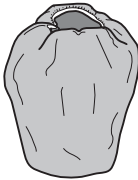
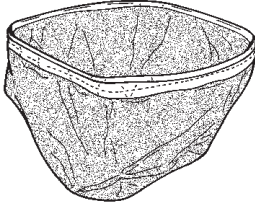
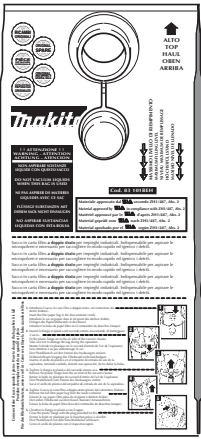
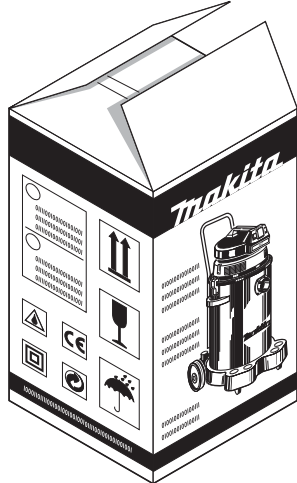
 A1	 A2	 A3	 A4
 A5	 A6	 A7	 A8
 A9	 A10	 A11	
 A12	 A13	 A14	
 A15	 A16		

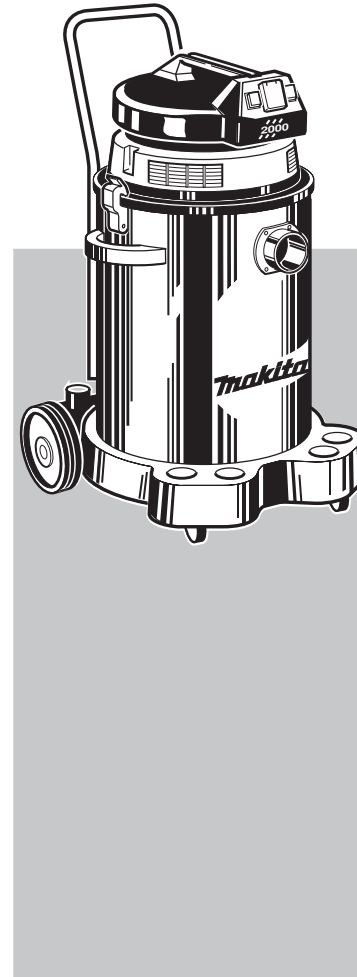

Pos.	Descrizione	Codice	Prezzo € (Cad)
A01	Tubo flessibile ø 45 - L=mt. 2 completo di manicotti	01316B0N	
A02	Tubo flessibile per elettroutensile ø 25 - L= mt. 3 completo di manicotti	01321B0N	
A03	Prolunga rigida ø 45	50091B0N	
A04	Impugnatura ergonomica ø 45	50093B0N	
A05	Anello deflussore	50095B0N	
A06	Bocchetta a lancia ø 45	50080B0N	
A07	Bocchetta triangolare ø 45	50089B0N	
A08	Spazzola multiuso ø 45	60277B0N	
A09	Inserto polvere	60279B0N	
A10	Racila per raccogliliquidi	60278B0N	
A11	Ghiera blocca cavo per A.S.S.	50318BHN	
A12	Cartuccia filtro "BIA" (conf. 6 pz.)	83200BEB	
A13	Filtro-mousse	83035BHB	
A14	Sacco filtro P.P. 380x390 H	83038B5A	
A15	Confezione sacco in carta filtro verticale BIA "C" (5 Pz.)	83132BEK	
A16	Imballo in cartone M445x	87010BEH	

Schema elettrico

Legenda colore cavi / Cable colour coding

W	Bianco / White
Bk	Nero / Black
R	Rosso / Red
Br	Marrone / Brown
Bl	Blu / Blue
Gr	Verde / Green
Y	Giallo / Yellow

* - con faston - with faston

